

SAFELY MADE IN THE USA. 

EPIDEMIC PROPORTIONS

800+ COVID-19 SAFETY IDENTIFICATION SOLUTIONS



IDENTIFICATION RESOURCES FOR A SAFE WORKFORCE

Protection

As your business begins operating during a pandemic, protecting the health and safety of workers, visitors, and customers is essential. Getting back to work is demanding a new level of commitment to safety. A lack of dedication and planning can result in a surge of failures as employers attempt to address the challenges of COVID-19.

Policies

Developing and implementing new health and safety policies to mitigate any rebounds or outbreaks when returning to work is essential now more than ever.

Identification

Convey the policies to be at the forefront of Sign, Label, and Tag products to identify the importance of safe and healthy practices around the COVID-19 pandemic. Proper and consistent directions and instructions empower visitors and employees to adapt to new policies, such as proper hygiene and social distancing.

Resource

Inside this COVID-19 Identification Book, you'll find over 800 safety identification resources to help you navigate the new health and safety signs you may need to adhere to state and local guidelines.

We're here to help you and stand with you as you promote a safe and healthy environment.



Coronavirus Disease 2019 (COVID-19) is a respiratory disease caused by the SARS-CoV-2 virus. It has spread from China to many other countries around the world. Depending on the severity of COVID-19's global impacts, outbreak conditions—including those rising to the level of a pandemic—can affect all aspects of daily life, including travel, trade, tourism, food supplies, and financial markets.

TABLE OF CONTENTS

INFORMATIONAL POSTERS	5
HAND HYGIENE	
HAND WASHING	6–7
HAND SANITIZING	8
HOUSEKEEPING	
CLEAN WORKSPACES	9
HYGIENE SUPPLY STATIONS	10
HEALTH & SAFETY GUIDELINES	
ENTRANCE SAFETY	11
TEMPERATURE CHECK	12
ENTRANCE	
FACE MASK/COVERING	13
WAITING AREA	14
SOCIAL DISTANCING	
REMINDER BANNERS	15
REMINDER BADGES	16
SIGNS	17
MAXIMUM CAPACITY	18
DOOR LABELS	19
FLOOR SIGNS	20–22
LED PROJECTION SIGNS	23
DIRECTIONAL SIGNS	24–26
POST BARRIERS	27
BARRICADE TAPES	28
PARTITION PANELS	29–30
RESTAURANT & RETAIL	
STORE ENTRY SIGNS	31
FLOOR SIGNS	32
CHECK OUT, CASH REGISTER	33
CURBSIDE PICK-UP	34
OPEN	35
CLOSED	36
CONTAINMENT/QUARANTINE	
CONTROLLED AREA	37–38
BIOHAZARD	39
CONSTRUCTION	
ENTRANCE SIGNS	40
ENTRANCE BANNERS	41
HARD HAT STICKERS	42
PPE	
FACE SHIELDS	43
STRAPS CLIP	44
DISPOSABLE WORK MATS	45–46

Materials

To provide a solution for your exact needs, we offer a comprehensive selection of materials designed to meet virtually every application and environmental demand from the parking lot to aisle ways, we've got you covered.

Signs

Adhesive Vinyl – Flexible vinyl with printed surface. Mount with permanent acrylic adhesive back with peel off liner. Ideal for indoor and protected outdoor placement.

Plastic – Printed surface has clear UV Duck Armor™ protective overcoat. 50% recycled content plastic has UV inhibitors. Rounded corners with mounting holes. Ideal for indoor and sheltered outdoor locations.

Aluminum – Rigid metal strength, without rust. Print is protected by UV Duck Armor™ overcoat to withstand washdown, abrasion, and chemical splash. Rounded corners with mounting holes. Durable for tough indoors and harsh outdoor environments.

Reflective Aluminum – Engineer-grade prismatic reflective thick aluminum provides added visibility in lowlight conditions. Image has clear overcoat protection by Duck Armor™. Rounded corners with center post-mount holes. Durable for outdoor location placement.

Counter Top Plastic – Rigid plastic sign has base bent at an angle to stand upright by itself on countertop, reception desk, or other areas to be readily seen and understood.

Dura-Plastic – High durability plastic with high-impact resistance for outdoor applications and tough environments. Image is clear-coat protected by Duck Armor™. Rounded corners with mounting holes.

Magnetic – Flexible magnetic vinyl can place, lift, and replace on most steel or ferrous metal.

SignPad – Thin-mil poly plastic signs together, pull off pad to use. Ideal to temporarily set out for placement.

Rope Sign – Plastic sign with cutout to loop barrier rope through to hang.

Lite-Corrugate Plastic – Light duty plastic with a fluted core. Ideal for attaching to any location or set out into ground with step-stake (not included).

90D Projection Sign – Durable thick plastic with a flange edge and mounting holes. 90D signs project from the wall at 90 degrees and can be viewed from either side, easily mounted with Tapes and Screws, not included

Floor Marking

Slip-Gard™ Floor Sign – Made of dual-layer tough construction. The underlayer is adhesive vinyl, and the sign is subsurface print. Non-slip, pebble-textured has an over-laminate top surface to provide added durability, protecting the graphics and message from heavy pedestrian traffic. Strong, permanent acrylic adhesive underside has a peel-off liner and adheres firmly to smooth, clean, dry surfaces.

Stand-Up Floor Signs

Fold-Ups® – High-impact plastic panels stand upright with bold message and symbol on both sides. Quick, easy set-up, transport with cut-out top handle, and folds flat for storage.

Triple-Sided Fold-Ups® – Lightweight corrugated plastic stand-up floor sign has printed messages on three sides. Set up and secure with insert tabs. Store flat when not in use.



Tags & Tapes

Safety Tags:

PF-Cardstock is thin-mil poly-flexible plastic with a top hole.

RP-Plastic is a durable, flexible plastic with a metal grommet top hole.

Tags By-The-Roll – End-to-end quantity of thin-mil poly tags connected, spooled, and stored within a handy portable box. Pull tag out to dispense out, tear at perforations to use.

Bottle Tags – PF-Cardstock is thin-mil, poly-flexible plastic with adjustable top hole to fit over top of bottle.

Barricade Tapes – Lightweight, thin poly plastic non-adhesive tape is durable for inside and outside use. Message is repeated continuously along the length of the tape roll. Easily cut and secure with adhesive tape, nail, staples, or tie-off.

Labels

Hard Hat Stickers – Stickers are flexible to conform to the hard hat curvature – or adhere to machinery, toolboxes, or other equipment.

Adhesive Vinyl – Flexible vinyl with printed surface and a permanent acrylic adhesive back with peel-off liner.

Cling-Tite – Clear static poly, adheres to surface, yet can peel off to remove, and replace.

Paper Labels – Printed surface on flexible paper stock with adhesive back with peel-off liner.

Badges – Poly-gloss, printed plastic card with slot hole top. Clip included.

Posters & Banners

Coated Paper Poster – Print on semi-gloss finish on coated side of heavy stock that is sturdier than writing paper. Uncoated backside allows mounting with adhesive.

Laminated Plastic Poster – Printed poster is laminated on both sides with clear laminate for added durability. Protective surface is cleanable with easy wipe off.

Poly Banner – Durable, reinforced, flexible poly with finished edges and metal grommets for mounting.

Mesh Banner – Poly-mesh texture is porous for wind-resistance to allow flow through the air. Tight mesh pattern provides visibility of printed surface. Has finished edges with metal grommets for mounting.

Duck Armor™ Liquid Laminate

Duck Armor™ is powerful enough to survive in any environment. Pioneered by Accuform® more than a decade ago, our **scientifically strong liquid laminate** coating sleeps with one eye open to protect over 90,000 identification product SKUs for superior protection against harsh chemicals, abuse, and graffiti without added cost.



Visit Accuform.com/DuckArmor to Learn More and See the Duck in Action!

Look for the  identifying products protected with Duck Armor™.



PERSONALIZE IT!

Customizing your safety signage keeps your company top of mind with your employees and customers while reinforcing your commitment to safety.

Whether you need a custom message, a personalized design with original imagery and logos, or require a unique shape or size, our “Yes, We Can!” approach will shine through when we create the right sign, label, tag, or floor marking solution for you.

Custom Safety Identification:

- No Set-Up Fees
- Unlimited Design Options
- No Minimums
- Language Translations Available

Contact us at customerservice@accuform.com or call 1-800-237-1001 for more information, to request quote, and for translation requirements.



Preventative Posters

Keep employees and customers informed about health and safety precautions with eye-catching informational posters. Hang posters on walls in key locations to provide as a regular reminder and reference.

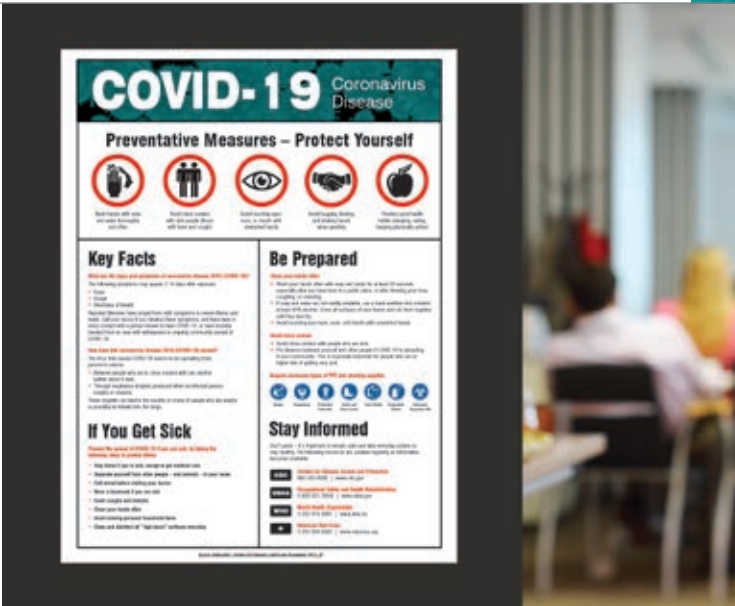

English SP125300
 Spanish SP125300SP
 French SP125300FR



English SP125301
 Spanish SP125301SP



English SP125302
 Spanish SP125302SP

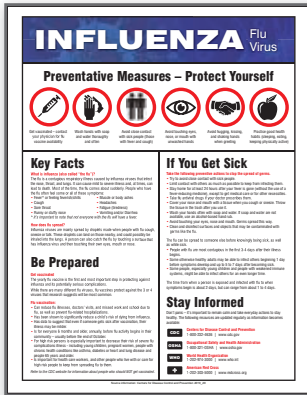

SP124498



SP125087



FFCRA	SIZE	NO.
English	11" x 8.5"	PPG106
Bilingual	17" x 11"	PPG206

To order, add code after part number.

STYLE	22"H X 17"W STANDARD CODE	28"H X 22"H JUMBO CODE
Non-Laminated**	As Listed	J
Laminated	L	JL

** ⚠️ **WARNING:** Reproductive Harm – www.P65Warnings.ca.gov

See Pages 2-3 for Material Descriptions.

PERSONALIZE It!

Posters can be custom printed with your message, graphic, or logo. Contact us with part number PST555.

CREATE YOUR OWN

Hand Washing

Promote proper hand hygiene procedures throughout the workplace to prevent the spread of germs and viruses. Install signs, labels, and posters around washrooms, bathrooms, sinks, and other areas available to wash hands.



Posters



P4850



SP125088



SP125089

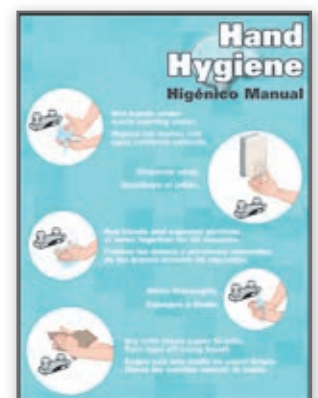

SP124486

To order, add code after part number.

STYLE	22" H X 17" W STANDARD CODE	28" H X 22" H JUMBO CODE
Non-Laminated**	As Listed	J
Laminated	L	JL

** ⚠️ **WARNING:** Reproductive Harm – www.P65Warnings.ca.gov

PERSONALIZE IT!

Posters can be custom printed with your message, graphic, or logo. Contact us with part number PST555.

CREATE YOUR OWN

See Pages 2–3 for Material Descriptions.

Signs



7" x 10" MRST811
10" x 14" MRST805



7" x 10" MHSK817
10" x 14" MRST815



10" x 14" MRST807



10" x 7" MRST826
14" x 10" MRST828



7" x 10" MRST812
10" x 14" MRST813



7" x 10" MRST902
10" x 14" MRST904



7" x 10" MRST591
10" x 14" MRST593



14" x 10" MRST541



10" x 7" MRST570
14" x 10" MRST540



10" x 7" MRST597
14" x 10" MRST599



10" x 7" MRST590
14" x 10" MRST592



7" x 10" MFSY506
10" x 14" MFSY556



10" x 7" MRST594
14" x 10" MRST596

To order, add material code after part number. More sign materials are available at Accuform.com.

MATERIAL	CODE
Adhesive Vinyl	VS
Plastic*	VP
Aluminum*	VA

PERSONALIZE It!

Signs can be custom printed with your message, graphic, or logo. Contact us for a quote.

CREATE YOUR OWN

Label



3 1/2" x 5" LRST512

To order, add material code after part number.

MATERIAL	UNIT	CODE
Adhesive Vinyl	Pkg. of 5	VSP
Dura-Vinyl™	Each	XVE

PERSONALIZE It!

Labels can be custom printed with your message, graphic, or logo. Contact us for a quote.

CREATE YOUR OWN



Hand Sanitizing

Remind others to use hand sanitizer when without soap and water, and rub hands together, until hands feel dry, which should take around 20 seconds. Install signs wherever hand sanitizers are located to rid bacteria from the hands.



To order, add material code after part number. More sign materials are available at Accuform.com.

MATERIAL	CODE
Adhesive Vinyl	VS
Plastic*	VP
Aluminum*	VA

Signs



10" x 7" MRST830
14" x 10" MRST832



7" x 10" MFSY573
10" x 14" MRST503



10" x 7" MRST587
14" x 10" MRST589

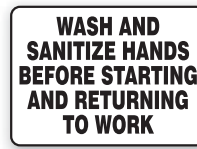

7" x 10" MFSY512
10" x 14" MHSK566

PERSONALIZE It!

Signs can be custom printed with your message, graphic, or logo. Contact us for a quote.



Hand Sanitize Bottle Tags

Place tags over dispenser pump on bottle to promote the use of sanitizers.



TAD705

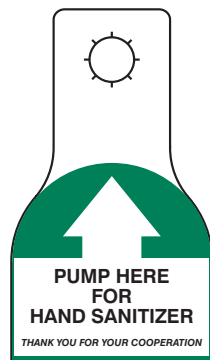

TAD703



TAD701

SIZE	MATERIAL	UNIT
5 3/4" x 3 1/4"	PF-Cardstock	Pkg. of 10

PERSONALIZE It!

Tags can be custom printed with your message, graphic, or logo. Contact us with part number TAD755.



*This material is protected with Duck Armor™ Liquid Laminate at no additional cost, courtesy of Accuform. See page 4 for more information about Duck Armor™.

See Pages 2-3 for Material Descriptions.



Clean Workspaces

Encourage others to keep their workspaces clean and sanitized after every shift with workplace cleanliness signs. Place signs at key points as reminders to keep the area clean.

Signs



7" x 10" MHSK845
10" x 14" MHSK846



7" x 10" MHSK939
10" x 14" MHSK950



7" x 10" MHSK912
10" x 14" MHSK901



7" x 10" MHSK928
10" x 14" MHSK927



10" x 14" MHSK917

PERSONALIZE IT!

Signs can be custom printed with your message, graphic, or logo. Contact us for a quote.



To order, add material code after part number. More sign materials are available at Accuform.com.

MATERIAL	CODE
Adhesive Vinyl	VS
Plastic*	VP
Aluminum*	VA

See Pages 2-3 for Material Descriptions.



*This material is protected with Duck Armor™ Liquid Laminate at no additional cost, courtesy of Accuform. See page 4 for more information about Duck Armor™.

Workplace Hygiene Supply Stations

Provide convenient access to supplies for cleaning and disinfection, plus PPE option, readily accessible, organized on a station board.

Constructed of durable thick aluminum* with mounted holders in either clear acrylic boxes or wire racks. The board on stand with casters can be mobile to the location for cleaning.

Cleaning supplies and products not included



PRF303

Clean & Disinfect Station

Includes space holders for the following:

- Disposable Gloves
- Hand Sanitizer
- Paper Towels
- Disinfecting Wipes
- Cleaning / Disinfecting Spray Bottle
- Alcohol Wipes

STYLE	BOARD SIZE	OVERALL DIMENSIONS	NO.
Board Only	32"H x 24"W	32"H x 24"W	PRF303
Board w/Stand	32"H x 24"W	72"H x 24"W	PRF314



PRF311

Clean & Disinfect PPE Station

Includes space holders for the following:

- Disposable Gloves
- Safety Glasses
- Face Masks
- Disinfecting Wipes
- Cleaning / Disinfecting Spray Bottle
- Alcohol Wipes

STYLE	BOARD SIZE	OVERALL DIMENSIONS	NO.
Board Only	32"H x 27"W	32"H x 27"W	PRF300
Board w/Stand	32"H x 27"W	72"H x 27"W	PRF311

WARNING: Cancer and Reproductive Harm – www.P65Warnings.ca.gov

PERSONALIZE IT!

Stations can be customized. Contact us with part number PFR355 for a quote.

CREATE YOUR OWN



*This material is protected with Duck Armor™ Liquid Laminate at no additional cost, courtesy of Accuform. See page 4 for more information about Duck Armor™.

Entrance Safety

Communicate your health and safety policy for all to see and reduce the potential spread of viruses. Prevent those with symptoms from entering the location. Set out signs and Fold-Ups® at entry points, reception areas, and outside entrance of the facility.

Signs



10" x 14" MGNG924

10" x 14" MGNG560
12" x 18" MGNG561

7" x 10" MGNG904
10" x 14" MGNG914

14" x 10" MTKC516
18" x 12" MTKC518

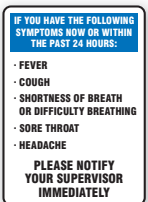

10" x 14" MGNG566
12" x 18" MGNG567

To order, add material code after part number. More sign materials are available at Accuform.com.

MATERIAL	CODE
Adhesive Vinyl	VS
Plastic*	VP
Aluminum*	VA

14" x 12" MGNG562
18" x 12" MGNG563



Countertop Stand-Up Signs

Rigid plastic sign has base bent at an angle to stand upright itself on countertop, reception desk, or other areas to be readily seen.



MATERIAL	SIZE	UNIT
Plastic	10" x 7"	Each

PNG105

PNG102

PNG101

PNG103

PNG104

Fold-Ups® Stand-Up Sign

MATERIAL	SIZE	UNIT
Plastic	20" x 12"	Each



PFR478

PERSONALIZE IT!

CREATE YOUR OWN

CREATE YOUR OWN

CREATE YOUR OWN

Signs, Countertop Stand-Up Signs, and Fold-Ups® can be custom printed with your message, graphic, or logo. Contact us for a quote.

⚠ **WARNING:** Cancer – www.P65Warnings.ca.gov



*This material is protected with Duck Armor™ Liquid Laminate at no additional cost, courtesy of Accuform. See page 4 for more information about Duck Armor™.

See Pages 2–3 for Material Descriptions.

Temperature Check

Identify stations or areas in which employees, workers, visitors, and customers are checked for fever, before entering the work area with signs, Fold-Ups®, and labels.



Signs



10" x 14" MGNG800



10" x 14" MGNG923



10" x 14" MGNG920



10" x 14" MGNG922



10" x 14" MGNG921

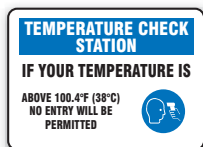

10" x 14" MGNG513

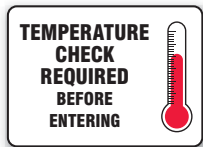

10" x 14" MGNG515



10" x 14" MGNG511



10" x 14" MGNG925

To order, add material code after part number. More sign materials are available at Accuform.com.

MATERIAL	CODE
Adhesive Vinyl	VS
Plastic*	VP
Aluminum*	VA

Fold-Ups® Stand-Up Sign

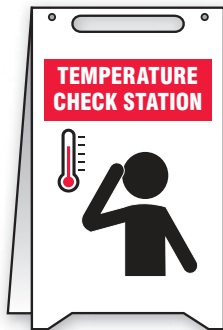

MATERIAL	SIZE	NO.	UNIT
Plastic	20" x 12"	PFR470	Each

⚠️ **WARNING:** Cancer – www.P65Warnings.ca.gov

Labels

Provide labels to wear, for those that passed the temperature check. Allows entry into the facility. Let others within know the person has passed the temperature check.

MATERIAL	SIZE	UNIT
Adhesive	2" dia.	Roll of 500
Coated Paper		



LDT205



LDT202



LDT203



LDT204

PERSONALIZE It!

Signs, Fold-Ups®, and Labels can be custom printed with your message, graphic, or logo. Contact us for a quote.



*This material is protected with Duck Armor™ Liquid Laminate at no additional cost, courtesy of Accuform. See page 4 for more information about Duck Armor™.

See Pages 2–3 for Material Descriptions.

Face Mask/ Face Covering

Reduce the spread of germs by promoting others to wear face mask and face cover. Place signs and Fold-Ups® at entry points, reception areas, and outside the facility's entrance to remind employees and visitors to wear face-coverings.



Fold-Ups® Stand-Up Sign



MATERIAL	SIZE	UNIT
Plastic	20" x 12"	Each

WARNING: Cancer – www.P65Warnings.ca.gov

Slip-Gard™ Floor Signs



12" MFS434
17" MFS436

12" MFS430
17" MFS432

UNIT
Each

Signs



10" x 7" MPPA830 10" x 7" MPPA920 10" x 7" MPPA501
14" x 10" MPPA832 14" x 10" MPPA922 14" x 10" MPPA503



10" x 7" MPPA510 10" x 7" MPPA514
14" x 10" MPPA512 14" x 10" MPPA516

To order, add material code after part number. More sign materials are available at Accuform.com.

MATERIAL	CODE
Adhesive Vinyl	VS
Plastic*	VP
Aluminum*	VA

PERSONALIZE It!

Signs, Floor Signs, and Fold-Ups® can be custom printed with your message, graphic, or logo. Contact us for a quote.



See Pages 2–3 for Material Descriptions.



*This material is protected with Duck Armor™ Liquid Laminate at no additional cost, courtesy of Accuform. See page 4 for more information about Duck Armor™.

Waiting Area

Direct visitors to the waiting area, but remind them to practice pandemic etiquette before or immediately after stepping through the front doors of your facility with entrance Countertop Stand-Up Signs and Fold-Ups®.



Countertop Stand-Up Signs

Rigid plastic sign has base bent at an angle to stand upright itself on countertop, reception desk, or other areas to be readily seen.



MATERIAL	SIZE	NO.	UNIT
Plastic	10" x 7"	PNG103	Each

Fold-Ups® Stand-Up Sign



MATERIAL	SIZE	NO.	UNIT
Plastic	20" x 12"	PFR476	Each

⚠️ **WARNING:** Cancer – www.P65Warnings.ca.gov

PERSONALIZE IT!

Countertop Stand-Up Signs, and Fold-Ups® can be custom printed with your message, graphic, or logo. Contact us for a quote.

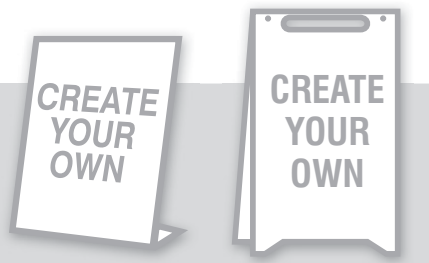

See Pages 2–3 for Material Descriptions.



FBW334

Entrance Reminder Banners

Effectively communicate social distancing by placing banners at the front of your business to ensure safety procedures are followed. Ideal for large spaces outside or inside the open area, hang to be seen from a distance.

SIZE	UNIT
46" x 10-ft.	Each

WARNING: Cancer and Reproductive Harm – www.P65Warnings.ca.gov



FBW330

PERSONALIZE It!

Banners can be custom printed with your message, graphic, or logo. Contact us with part number MBR530.



FBW332

See Pages 2–3 for Material Descriptions.



Reminder Badges

Take action in preventing the spread of COVID-19 by using these motivational ID badges to alert others to practicing social distancing. Wear the motivational badge to promote social distancing.

Laminated plastic with clip Included.

To order pkg of 25, add material code after part number.

SIZE	EACH	PKG/25
3.375" x 2.125"	As Listed	P

PERSONALIZE IT!

Badges can be custom printed with your message, graphic, or logo. Contact us with part number DNT655.



DNT905



DNT906



DNT904



DNT901



DNT902



DNT903

See Pages 2-3 for Material Descriptions.

Signs

Encourage and provide awareness to social and physical distance to prevent the spread of germs, viruses, diseases, flu, and Coronavirus COVID-19.

Social distancing means to remain away from congregating settings, avoid mass gatherings, and maintain distance approximately 6 feet or 2 meters from others when possible.

Install signs from the entrance areas to throughout as reminders at workplaces, offices, industrial facilities, retail locations, commercial establishments including restaurants, grocery stores, other places of business to remind of social distancing.



To order, add material code after part number. More sign materials are available at Accuform.com.

MATERIAL	CODE
Adhesive Vinyl	VS
Plastic*	VP
Aluminum*	VA



10" x 7" MGNG909
14" x 10" MGNG908



10" x 7" MGNG901
14" x 10" MGNG905



10" x 7" MGNG903
14" x 10" MGNG907



10" x 7" MGNG902
14" x 10" MGNG906



10" x 7" MGNF547
14" x 10" MGNF549



10" x 7" MGNF537
14" x 10" MGNF539



7" x 10" MGNF540
10" x 14" MGNF542



7" x 10" MGNF544
10" x 14" MGNF546

PERSONALIZE It!

Signs can be custom printed with your message, graphic, or logo. Contact us for a quote.

CREATE YOUR OWN

See Pages 2-3 for Material Descriptions.



*This material is protected with Duck Armor™ Liquid Laminate at no additional cost, courtesy of Accuform. See page 4 for more information about Duck Armor™.



Maximum Capacity

Ensure your facility doesn't exceed capacity. Areas could be limited to provide proper social distancing for people in attendance, based on available space. Set out signs at entry points, reception areas, and outside the entrance of the facility.

Signs



10" x 14" MCAP503



10" x 14" MCAP502



7" x 10" MCAP510
10" x 14" MCAP505

Semi-Custom Signs - Provide your information.



10" x 14" MCAP514



10" x 14" MCAP513



10" x 14" MCAP516

To order, add material code after part number. More sign materials are available at Accuform.com.

MATERIAL	CODE
Adhesive Vinyl	VS
Plastic*	VP
Aluminum*	VA

PERSONALIZE IT!

Signs can be custom printed with your message, graphic, or logo. Contact us for a quote.



*This material is protected with Duck Armor™ Liquid Laminate at no additional cost, courtesy of Accuform. See page 4 for more information about Duck Armor™.

See Pages 2-3 for Material Descriptions.



Cling – Clear shown

Entrance Door Labels

Remind others to practice social distancing and stay 6 feet apart from others before they walk through the entrance with door labels.

To order, add material code after part number.

MATERIAL	CODE	UNIT
Cling – Clear	CP	Pkg. of 5
Adhesive Vinyl – Opaque	VSP	Pkg. of 5

PERSONALIZE It!

Labels can be custom printed with your message, graphic, or logo. Contact us for a quote.



4" LADM412
6" LADM414



4" LADM400
6" LADM402



4" LADM404
6" LADM406



4" LADM408
6" LADM410

See Pages 2–3 for Material Descriptions.

Slip-Gard™ Floor Signs

Pebble-texture, dual-layer adhesive vinyl.

Reinforce social distancing practices in your business by placing floor signs to locate where to stand and move to for proper distancing requirements in areas where lines and queues occur.



UNIT
Each



12" MFS384
17" MFS386



12" MFS380
17" MFS382



12" MFS389
17" MFS391



12" MFS388
17" MFS390



12" MFS381
17" MFS383



12" MFS385
17" MFS387



12" MFS345
17" MFS347



12" MFS350
17" MFS352



12" MFS354
17" MFS356



12" MFS334
17" MFS336



12" MFS338
17" MFS340



12" MFS341
17" MFS343



12" MFS420
17" MFS421



12" MFS422
17" MFS423



12" MFS424
17" MFS425

See Pages 2-3 for Material Descriptions.



12" MFS426
17" MFS427



12" MFS428
17" MFS429



12" MFS342
17" MFS344

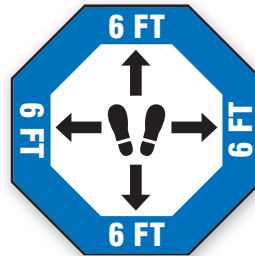

12" MFS346
17" MFS348

UNIT
Each



6" x 24" PSR290



3" x 36" PSR901



6" x 24" PSR295



3" x 36" PSR903

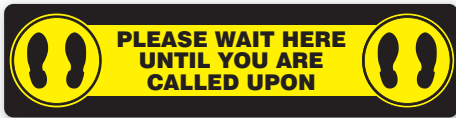

6" x 24" PSR292



3" x 36" PSR905



6" x 24" PSR291



3" x 36" PSR907



6" x 24" PSR294



3" x 36" PSR909



6" x 24" PSR296



3" x 36" PSR911



6" x 24" PSR293



3" x 36" PSR915

See Pages 2-3 for Material Descriptions.



12" MFS351
17" MFS353



12" x 18" PSR304



12" x 18" PSR301



12" MFS357
17" MFS359



12" x 18" PSR302



12" x 18" PSR303



12" MFS430
17" MFS432



12" x 18" PSR300

UNIT
Each



12" MFS434
17" MFS436

PERSONALIZE It!

Floor Signs can be custom printed with your message, graphic, or logo. Contact us with part number MFS555.

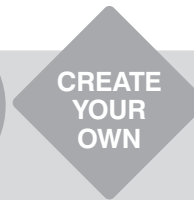

See Pages 2-3 for Material Descriptions.

LED Projection Floor Signs

When standard safety signs don't work in challenging environments - social distancing LED Sign Projectors are the ideal solution you need.

Heavy-duty cast aluminum projector contains a CREE high-powered LED chip with 3-ft, plug-in 110 VAC power cord. Includes remote control, up to 32-ft away, for on/off operation plus rotation or still for sign image. Viewing distance by light level: complete dark - 262-ft.; dim light - 65-164-ft.; bright light - 49-ft. *For indoor use only.



UNIT
Each

⚠ WARNING: Cancer and Reproductive Harm – www.P65Warnings.ca.gov



VPL943



VPL942



VPL940



VPL941



VPL944



VPL946



VPL901



VPL945

PERSONALIZE It!

LED Projection Floor Signs can be custom printed with your message, graphic, or logo. Contact us with part number VPL955.



Slip-Gard™ Floor Signs – Directional

Pebble-texture, dual-layer adhesive vinyl.

Keep the traffic moving in a safe direction in your business. Place directional arrows at entry points and in areas where the opposite direction may be too close for a social distance.



UNIT
Each



12" MFS470
17" MFS472



12" SBMFS470
17" SBMFS472



12" MFS464
17" MFS466



12" MFS474
17" MFS476



12" SBMFS474
17" SBMFS476



12" MFS451
17" MFS453



12" SBMFS451
17" SBMFS453



12" MFS457
17" MFS459



12" MFS460
17" MFS462



12" SBMFS460
17" SBMFS462

See Pages 2–3 for Material Descriptions.



12" MFS482
17" MFS483



12" MFS480
17" MFS481



12" MFS471
17" MFS473



12" MFS475
17" MFS477



12" MFS484
17" MFS485



6" x 24"

PSR101



6" x 24"

PSR102



6" x 24"

PSR103



6" x 24"

SBPSR101



6" x 24"

SBPSR102



6" x 24"

SBPSR103



12" MFS465
17" MFS467



12" MFS461
17" MFS463

UNIT
Each

PERSONALIZE It!

Floor Signs can be custom printed with your message, graphic, or logo. Contact us with part number MFS555.



See Pages 2-3 for Material Descriptions.

Directional Signs

Post the specific direction to head down aisles, lanes, and hallway to remind practice social distancing. Install on wall or shelves at entry points and intervals to direct proper direction. The sign stands out to be viewed from either side – correct direction one side, and the reverse side states the incorrect path.

90D Projection Signs



Back

90D – 12" x 9" Panel PSP207



Back

90D – 12" x 9" Panel SHPSP207



Back

90D – 12" x 9" Panel PSP209



Back

90D – 12" x 9" Panel SHPSP209



Back

90D – 12" x 9" Panel PSP205



Back

90D – 12" x 9" Panel SHPSP205

MATERIAL	PANEL SIZE	OVERALL SIZE	UNIT
Plastic	12" x 9"	12" x 9" x 1 1/2"	Each



Triple-sided Fold-Ups®

The stand-up floor sign has a printed message on three sides. Set up and secure with insert tabs.



48" x 20" Panel PFE360



48" x 20" Panel PFE362

MATERIAL	OVERALL SIZE	UNIT
Corrugated Plastic	48"H x 62.49"W	Each

See Pages 2–3 for Material Descriptions.

BLOCKADE Retractable Belt Tape Post Barriers

Connect belt tape in combination with posts to control and direct the flow of pedestrian traffic for social distancing purposes. Set posts out and extend the belt tape to locate where to stand and move in areas where lines and queues occur. Install at the entry point and throughout to direct the pedestrian traffic.

2" woven polyester tape is wound in self-tension spring-loaded unit. Retracts smoothly and safely into the head unit for storage.

The post is 2 1/2" diameter x 38"H with a 14" diameter weighted base.



BLOCKADE Retractable Belt Tape Receiver Post

For indoor use only



SIZE	UNIT
2" x 13-ft.	Each

Outdoor Retractable Belt Tape Post



UNIT
Each



10-ft. PRT202
15-ft. PRT210



10-FT. PRT206
15-FT. PRT214

PERSONALIZE It!

Retractable Belt Tape Post Barriers can have custom colors and messages. Contact us for a quote.

CREATE YOUR OWN

Barricade Tapes

Prevent others from crossing into unsafe areas by temporarily sectioning off to identify social distancing areas with highly visible barricade tapes and protect their health and safety.

Unspool off the length of tape with bold warning message is continuously repeated the length of the roll. Lightweight, thin polyethylene plastic non-adhesive tape is durable for indoor and outdoor environments. Easily cut and secure with adhesive tape, nail, staples, or tie-off.



SIZE	UNIT
3" x 1000-ft.	Roll



MPT317



MPT307



MPT308



MPT304



MPT305



MPT321



MPT315



MPT302

PERSONALIZE It!

CREATE YOUR OWN

Barricade Tapes can be custom printed with your message, graphic, or logo. Contact us with part number MPT555.

See Pages 2-3 for Material Descriptions.

Accu-Shield™ DP-X Mobile Partition Panels

When workers are unable to practice social distancing, ensure they have a mobile partition shield to prevent the spread of viruses like COVID-19

Divider partition panels can section a work area in industrial, office, and commercial settings while maintaining unobstructed views. Roll panel on included swivel casters* to location. Constructed of a lightweight, industrial-grade aluminum frame with an optically clear, impact-resistant plastic panel.

* 24" leg supports 12" on each side.



	UNIT
	Each



Shared Desk Divider
Shield size: 36"H x 48"W
Overall size: 71"H x 48"W
PRD302



Small Mobile Partition
Shield size: 47"H x 23"W
Overall size: 78"H x 26"W
PRD602



Large Mobile Partition
Shield size: 47"H x 47"W
Overall size: 78"H x 50"W
PRD604

PERSONALIZE It!

Mobile Partition Panels can be customized. Contact us with part number PRD555.



Accu-Shield™ SG Clear Barrier Panels

Provide sneeze guard style protection throughout work areas in offices, warehouses, and commercial settings with unobstructed views while safeguarding workers, customers, and visitors against the spread of germs and viruses.

Set up Barrier Panels easily, to keep in place or move to other work areas, or store flat when not in use. A thick clear shield is a high-impact thermoplastic that is chemical-resistant to many cleaners.



Countertop-Desktop Panels

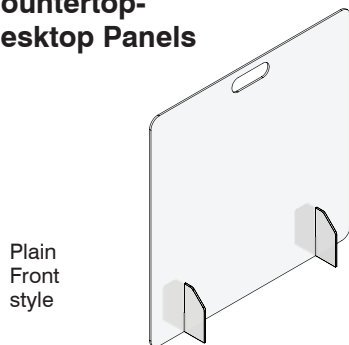

Plain Front style

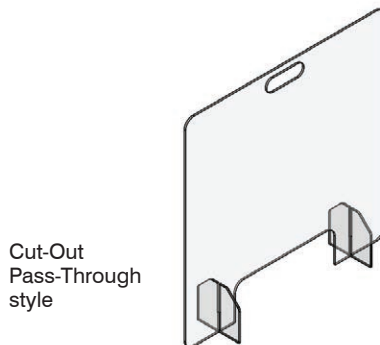

Cut-Out Pass-Through style

SIZE	PLAIN FRONT NO.	CUT-OUT PASS-THROUGH NO.
24"H x 24"W	PRL100	PRL201
24"H x 36"W	PRL101	PRL202
Other custom size	PRL155	PRL255

4-Way Table Dividers

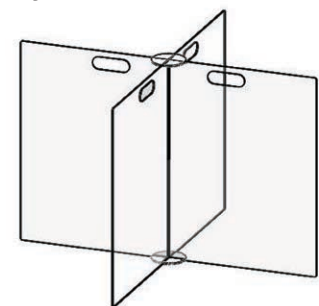

FITS TABLE SIZE	NO.
36"	PRL400
48"	PRL401
Other custom size	PRL455

Countertop-Desktop Panels with Side Wings

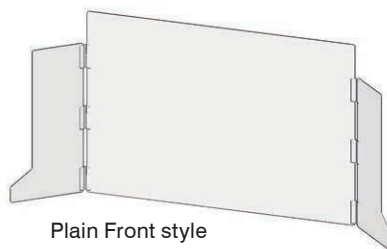

Plain Front style

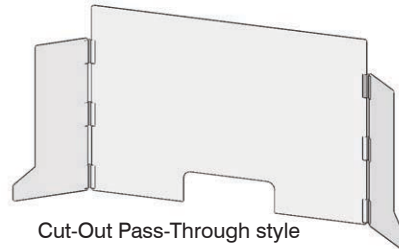

Cut-Out Pass-Through style

PANEL SIZE	OVERALL SIZE	PLAIN FRONT NO.	CUT-OUT PASS-THROUGH NO.
24"H x 36"W	24"H x 56"W	PRL300	PRL700
24"H x 48"W	24"H x 68"W	PRL301	PRL701
Other custom size	other	PRL355	PRL755

Hanging Panels

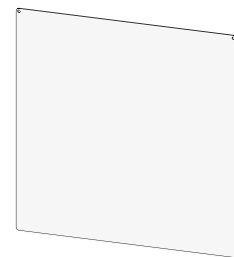

SIZE	NO.
30"H x 30"W	PRL600
30"H x 36"W	PRL601
Other custom size	PRL655

PERSONALIZE IT!

Clear Barrier Panels can be customized to meet your requirements. Contact us for a quote.

CREATE YOUR OWN

Store Entry Signs

Alert customers and visitors to practice social distancing while shopping at your business by placing signs at the entrance.



10" x 7" MGNG909
14" x 10" MGNG908



10" x 7" MGNG901
14" x 10" MGNG905



10" x 7" MGNG903
14" x 10" MGNG907



10" x 7" MGNG902
14" x 10" MGNG906



10" x 7" MGNF547
14" x 10" MGNF549



10" x 7" MGNF537
14" x 10" MGNF539

To order, add material code after part number. More sign materials are available at Accuform.com.

MATERIAL	CODE
Adhesive Vinyl	VS
Plastic*	VP
Aluminum*	VA

PERSONALIZE It!

Signs can be custom printed with your message, graphic, or logo. Contact us for a quote.

CREATE
YOUR OWN

See Pages 2–3 for Material Descriptions.



*This material is protected with Duck Armor™ Liquid Laminate at no additional cost, courtesy of Accuform. See page 4 for more information about Duck Armor™.

Slip-Gard™ Floor Signs

Pebble-texture, dual-layer adhesive vinyl.

Floor signs provide foot traffic direction in areas too close for distancing requirements and locate where others should stand throughout a store, retail location, or other businesses. Place floor signs in areas wherever lines and queues occur to keep others safe.



12" MFS460
17" MFS462



12" SBMFS460
17" SBMFS462



12" MFS474
17" MFS476



12" SBMFS474
17" SBMFS476



12" MFS350
17" MFS352



12" MFS354
17" MFS356



12" MFS330
17" MFS332



12" MFS465
17" MFS467



6" x 24" PSR101



6" x 24" PSR295

PERSONALIZE It!

Floor signs can be custom with your message, graphic, or logo. Contact us with part number MFS555.

CREATE YOUR OWN

UNIT
Each



*This material is protected with Duck Armor™ Liquid Laminate at no additional cost, courtesy of Accuform. See page 4 for more information about Duck Armor™.

See Pages 2-3 for Material Descriptions.

Check Out, Cash Register

Prevent customers from crowding forward or too close together for everyone's health and safety to avoid germs, viruses, and flu. Inform the importance of social distancing when waiting to check out at a store. Place signs by the cash register, near or along with the checkout lane areas.



Signs

7" x 10" MGNG520 10" x 14" MGNG522	7" x 10" MGNG535 10" x 14" MGNG537	10" x 7" MGNG531 14" x 10" MGNG533	10" x 7" MGNG528 14" x 10" MGNG530	7" x 10" MGNG539 10" x 14" MGNG541	7" x 10" MGNG524 10" x 14" MGNG526

To order, add material code after part number. More sign materials are available at Accuform.com.

MATERIAL	CODE
Adhesive Vinyl	VS
Plastic*	VP
Aluminum*	VA

PERSONALIZE It!

Signs can be custom printed with your message, graphic, or logo. Contact us for a quote.

CREATE YOUR OWN

Fold-Ups® Stand-Up Sign

PFR119	PFR120

MATERIAL	SIZE	UNIT
Plastic	20" x 12"	Each

WARNING: Cancer – www.P65Warnings.ca.gov

PERSONALIZE It!

Fold-Ups® can be custom printed with your message, graphic, or logo. Contact us with part number PFR555.

CREATE YOUR OWN

See Pages 2–3 for Material Descriptions.



*This material is protected with Duck Armor™ Liquid Laminate at no additional cost, courtesy of Accuform. See page 4 for more information about Duck Armor™.

Curbside Pick-Up

Identify curbside service location and availability. Post signs where customers drive up, identify where they should park, and where to wait for pick-up.



MATERIAL	UNIT
Reflective Aluminum*	Each



18" x 12" FRP660RA
24" x 18" FRP662RA



18" x 12" FRP680RA
24" x 18" FRP682RA



18" x 12" FRP664RA
24" x 18" FRP665RA



18" x 12" FRP668RA
24" x 18" FRP670RA



18" x 12" FRP684RA
24" x 18" FRP686RA



18" x 12" FRP691RA
24" x 18" FRP693RA



18" x 12" FRP676RA
24" x 18" FRP678RA



18" x 12" FRP695RA
24" x 18" FRP697RA

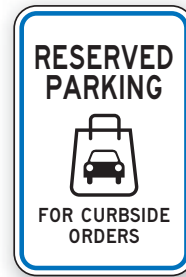

18" x 12" FRP672RA
24" x 18" FRP674RA



18" x 12" FRP661RA
24" x 18" FRP663RA

Lite-Corrugated Plastic



MPCR543



MPCR540



MPCR544



MPCR541



MPCR542

MATERIAL	SIZE	UNIT
Corrugated Plastic	18" x 24"	Each



*This material is protected with Duck Armor™ Liquid Laminate at no additional cost, courtesy of Accuform. See page 4 for more information about Duck Armor™.

See Pages 2-3 for Material Descriptions.

Open

Display hours of operation for when to come in or call in. Set signs in a visible area close to the entry door, and place banners in the open or up high to be readily seen from afar.

To order, add material code after part number. More sign materials are available at Accuform.com.

MATERIAL	CODE
Adhesive Vinyl	VS
Plastic*	VP
Aluminum*	VA



28" x 8-ft. MBR776

Signs



10" x 14" MADM582



10" x 14" MADM540



10" x 14" MADM580

Semi-Custom Signs - Provide your information.



10" x 14" MADM472



10" x 14" MADM474

Be Back Clock Sign
Dura-Plastic™*



SIZE	NO.	UNIT
8" x 5"	MPCM507	Each

SignPad™
Poly-plastic



SIZE	NO.	UNIT
10" x 14"	MTMP559	Pad of 25

Lite-Corr Plastic Sign



SIZE	NO.	UNIT
10" x 14"	MPCR511	Pkg. of 10

Banners



28" x 4-ft. MBR362



28" x 4-ft. MBR364



28" x 4-ft. MBR366

UNIT
Each

⚠ WARNING:
Cancer and Reproductive Harm
www.P65Warnings.ca.gov



28" x 8-ft. MBR774



28" x 8-ft. MBR772



*This material is protected with Duck Armor™ Liquid Laminate at no additional cost, courtesy of Accuform. See page 4 for more information about Duck Armor™.

See Pages 2–3 for Material Descriptions.

Closed

Identify 'closed' for daily operations, temporary, or long term. Place message close to the door, or out and up high to see from far away.



Signs



10" x 14" MADM544



10" x 14" MADM570

To order, add material code after part number. More sign materials are available at Accuform.com.

MATERIAL	CODE
Adhesive Vinyl	VS
Plastic*	VP
Aluminum*	VA

Rope Sign



10" x 14" FBR109

MATERIAL	UNIT
Plastic*	Each

SignPad™



10" x 14" MTMP527

MATERIAL	UNIT
Poly-plastic	Pad of 25

Lite-Corr Plastic Sign



10" x 14" MPCR500

UNIT
Pkg. of 10

Magnetic Sign



5" x 7" LHSK910
7" x 10" LHSK921

UNIT
Each

Label



18" x 2 1/2"
PRC305
24" x 4"
PRC315

UNIT
Each



*This material is protected with Duck Armor™ Liquid Laminate at no additional cost, courtesy of Accuform. See page 4 for more information about Duck Armor™.

See Pages 2-3 for Material Descriptions.

Controlled Area

Prevent people from entering into locations that are under decontamination procedures. Install Signs, Barricade Tapes, Fold-Ups®, and Tags By-The Roll, as they are easily seen by anyone attempting to go into the area in the process.



Signs



7" x 10" MBHZ134
10" x 14" MBHZ136



7" x 10" MBHZ130
10" x 14" MBHZ132



7" x 10" MBHZ131
10" x 14" MBHZ133



7" x 10" MBHZ135
10" x 14" MBHZ137



7" x 10" MHSK860
10" x 14" MHSK862



7" x 10" MBHZ810
10" x 14" MBHZ812



7" x 10" MBHZ814
10" x 14" MBHZ816

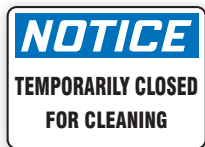

7" x 10" MHSK864
10" x 14" MHSK866



7" x 10" MBHZ563
10" x 14" MBHZ565



10" x 7" MBHZ570
14" x 10" MBHZ572

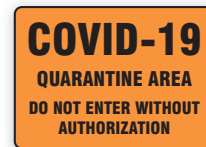

7" x 10" MBHZ567
10" x 14" MBHZ569

To order, add material code after part number. More sign materials are available at Accuform.com.

MATERIAL	CODE
Adhesive Vinyl	VS
Plastic*	VP
Aluminum*	VA



Signs can be custom printed with your message, graphic, or logo. Contact us for a quote.



Barricade Tape



SIZE	NO.	UNIT
3" x 1000-ft.	MPT301	Roll



Barricade Tapes can be custom printed with your message, graphic, or logo. Contact us with part number MPT555.



See Pages 2-3 for Material Descriptions.



*This material is protected with Duck Armor™ Liquid Laminate at no additional cost, courtesy of Accuform. See page 4 for more information about Duck Armor™.

CONTAINMENT

Fold-Ups® Stand-Up Sign



PFR165



PFR161



PFR163



PFR167



PFR836



PFR832



PFR834

MATERIAL	SIZE	UNIT
Plastic	20" x 12"	Each

PERSONALIZE It!

Fold-Ups® can be custom printed with your message, graphic, or logo. Contact us with part number PFR555.



Tags By-The-Roll



TAR222 - 100/Roll
TAR224 - 250/Roll



TAR210 - 100/Roll
TAR212 - 250/Roll



TAR214 - 100/Roll
TAR216 - 250/Roll



TAR218 - 100/Roll
TAR220 - 250/Roll



TAR226 - 100/Roll
TAR228 - 250/Roll



TAR235 - 100/Roll
TAR237 - 250/Roll



TAR280 - 100/Roll
TAR282 - 250/Roll



TAR284 - 100/Roll
TAR286 - 250/Roll



TAR281 - 100/Roll
TAR283 - 250/Roll

MATERIAL	UNIT
PF-Cardstock	Roll

PERSONALIZE It!

Tags By-The-Roll can be custom printed with your message, graphic, or logo. Contact us with part number for:

100/Roll No. TAR455; or 250/Roll No. TAR655



See Pages 2-3 for Material Descriptions.

Biohazard

Identify and communicate areas, and materials that are infectious, biological hazardous contaminants, and bloodborne pathogens. Post signs at locations and areas, or place labels and tags right on containers of biohazard.



Safety Tags



Front
MDT926

Back

To order, add material code after part number.

SIZE	PF-CARDSTOCK CODE	RP-PLASTIC** CODE	UNIT
5 3/4" x 3 1/4"	CTP	PTP	Pkg. of 25

** ⚠️ **WARNING:** Cancer and Reproductive Harm – www.P65Warnings.ca.gov

Label



SIZE	MATERIAL	NO.	UNIT
3 1/2" x 5"	Adhesive Vinyl	LBHZ506VSP	Pkg. of 5

Fold-Ups® Stand-Up Sign

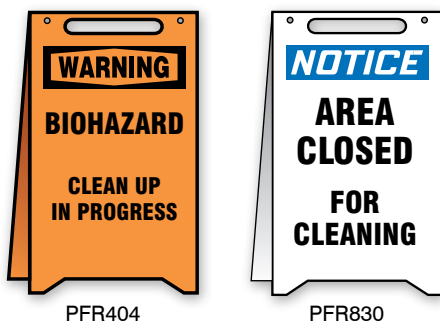

PFR404

PFR830

MATERIAL	SIZE	UNIT
Plastic	20" x 12"	Each

Signs



7" x 10" MBHZ303
10" x 14" MBHZ300



14" x 10" MBHZ321



14" x 10" MBHZ322



14" x 10" MBHZ323



14" x 10" MBHZ324

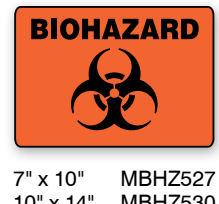

7" x 10" MBHZ527
10" x 14" MBHZ530



7" x 10" MBHZ311
10" x 14" MBHZ313

To order, add material code after part number. More sign materials are available at Accuform.com.

MATERIAL	CODE
Adhesive Vinyl	VS
Plastic*	VP
Aluminum*	VA

PERSONALIZE It!

Signs can be custom printed with your message, graphic, or logo. Contact us for a quote.

CREATE YOUR OWN

See Pages 2–3 for Material Descriptions.



*This material is protected with Duck Armor™ Liquid Laminate at no additional cost, courtesy of Accuform. See page 4 for more information about Duck Armor™.

Entrance Signs

Inform workers, contractors, and visitors at construction areas how to keep healthy, safe, and prevent the spread of the Coronavirus COVID-19 flu. Signs contain the preventative measures and guidelines identified by NAHB, AGC, CPWR, and IBEW. Post at entry points and areas where most people will see and read the contents.



24" x 36"
36" x 48" ECRT560
ECRT562



24" x 36" ECRT570
36" x 48" ECRT572



24" x 36" ECRT564
36" x 48" ECRT566



24" x 36" ECRT567
36" x 48" ECRT569

To order, add material code after part number.

MATERIAL	CODE
Contractor-Preferred Corrugated Plastic**	CC
Contractor-Preferred Aluminum*	CA

** ⚠️ **WARNING:** Cancer and Reproductive Harm – www.P65Warnings.ca.gov

PERSONALIZE IT!

Signs can be custom printed with your message, graphic, or logo. Contact us with your part number, Corrugated Plastic: PCR555 or Aluminum: VA555.

CREATE YOUR OWN

See Pages 2–3 for Material Descriptions.



*This material is protected with Duck Armor™ Liquid Laminate at no additional cost, courtesy of Accuform. See page 4 for more information about Duck Armor™.

Entrance Mesh Banners

Provide information to workers, contractors, and visitors at construction areas to maintain safety and health and stop the spread of the Coronavirus COVID-19 flu. Banners convey symbols and short statements identifying the guidance from NAHB, AGC, CPWR, and IBEW. Install at entrances and locations to gain attention.



24" x 36"
36" x 48"

ECRT564MBM
ECRT566MBM



FBW577



FBW575



FBW573



FBW571



24" x 36"
36" x 48"

ECRT570MBM
ECRT572MBM



24" x 36"
36" x 48"

ECRT567MBM
ECRT569MBM



24" x 36"
36" x 48"

ECRT560MBM
ECRT562MBM

MATERIAL	UNIT
Contractor-Preferred Mesh	Each

WARNING: Cancer and Reproductive Harm – www.P65Warnings.ca.gov

MATERIAL	SIZE	UNIT
Mesh	5-ft. x 10-ft.	Each

WARNING: Cancer and Reproductive Harm – www.P65Warnings.ca.gov

PERSONALIZE IT!

Entrance Mesh Banners can be custom printed with your message, graphic, or logo. Contact us with part number FBW555.

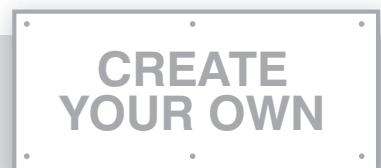

See Pages 2–3 for Material Descriptions.



Hard Hat Stickers

Convey the social distancing message on sticker labels to remind those when working together. Stickers are flexible to conform to the hard hat curvature – or adhere to machinery, toolboxes, or other equipment.

MATERIAL	UNIT
Adhesive Vinyl	Pkg. of 10

PERSONALIZE IT!

Hard Hat Stickers can be custom printed with your message, graphic, or logo. Contact us with part number LHTL555.



2 1/4" LHTL272



2 1/4" LHTL273



2 1/4" LHTL270



2 1/4" LHTL271

See Pages 2-3 for Material Descriptions.

Disposable Face Shield

Disposable, full-size face shield protects from dust, splashes, and sprays. Optically clear 14"W x 8"H x .020" shield provides peripheral visibility. One size fits most with plastic headband strap with adjustable rear hook & loop fastener to fit head circumference 17" – 26". For general-purpose non-sterile use. Shield also flips up and down with side aluminum rivets.



SIZE	NO.	UNIT
14"W x 8"H	LHB642	50 per Box

Clip-On Disposable Face Shield

Wear a light-duty face shield with the comfort of a baseball cap, bump cap, or protective hard hat to prevent the spread of germs and viruses, while reducing the chance of catching or causing cross-contamination and blocking light dust, dirt, mists, and sprays. This general-purpose, disposable face shield attaches to the cap's or hat's brim or visor with ease for both comfort and versatility.



SIZE	NO.	UNIT
10 1/2"W x 8"H	LHB640	50 per Box



Face Mask Straps Clip

Get relief from the mask strings on the ears that cause irritations, redness, abrasions, and blisters. A semi-flexible clip rests on the back of the head. Place mask strings onto the clip instead of the ears. Loop the mask strings onto the clip's multiple notches for an adjustable fit.

Plastic is sturdy, wear- and chemical-resistant that is easy to clean for reuse. Compact size, 1 1/2"H x 6 1/8"W x .035" thick.



SIZE	NO.	UNIT
1 1/2"H x 6 1/8"W	LHB630	Pkg. of 10

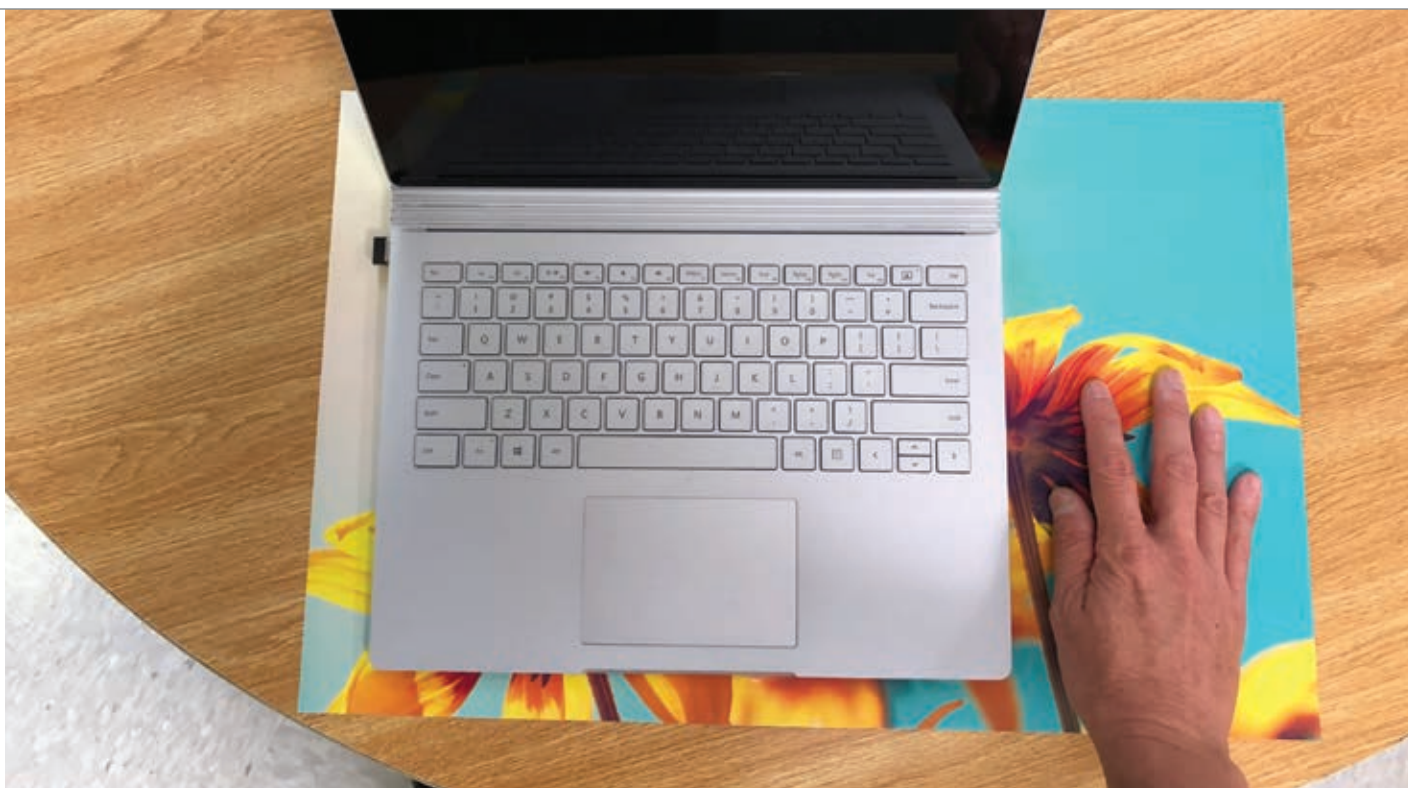

Table-Gard™ Disposable Work Mats

Get protection from germs, dirt, and chemical residue that may be on work table surfaces not regularly cleaned. Turn shared work surfaces - such as conference tables, counters, desktops, coffee shop, and restaurant tables – to be safe, clean workspaces with this stick-down mat.

Before setting out work materials, place the mat for a clean, sanitary, and germ-free surface.

Smooth, thin plastic film is 12.5" x 19.5" for work area large enough for laptops, and folios. Waterproof and tear-resistant with a peel-off adhesive backside that allows for reposition lift-off and lay back down.



Easy peel-off back liner tabs

SIZE

19 1/2"W x 12 1/2"H



LPM101



LPM102



LPM103



LPM104



LPM105



LPM106



LPM122



LPM123

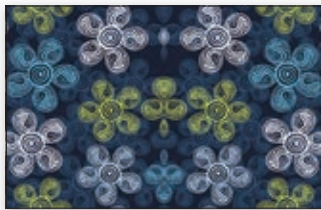

LPM124



LPM125

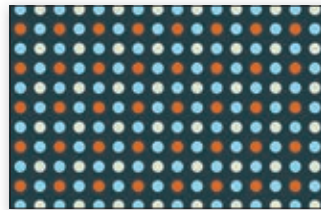

LPM126



LPM127



LPM143

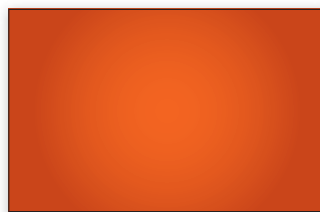

LPM144



LPM145



LPM146

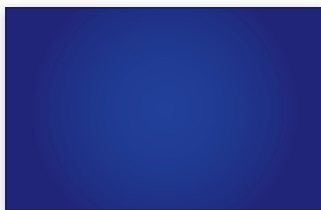

LPM147

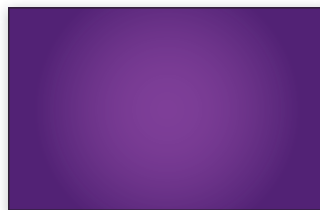

LPM148

Available in packs of 10, 25, and 50.

To order, add package quantity code after part number:
10 per pack – X, 25 per pack – P, 50 per pack – L.

PERSONALIZE IT!

Table-Gard Disposable Work Mats can be custom printed with your message, graphic, or logo. Contact us with part number LPM155.

CREATE YOUR OWN



PRACTICE GOOD HAND WASHING HYGIENE

Ensure proper handwashing procedures are practiced throughout the workplace to prevent the spread of germs and viruses.

▶ See Page 6

PERSONALIZE IT!

Customizing your safety signage keeps your company top of mind with your employees and customers while reinforcing your commitment to safety.

Whether you need a custom message, a personalized design with original imagery and logos, or require a unique shape or size, our “Yes, We Can!” approach will shine through when we create the right sign, label, tag, or floor marking solution for you.

Custom Safety Identification:

- No Set-Up Fees
- Unlimited Design Options
- No Minimums
- Language Translations Available



[Click to learn more](#) about over 800 stock and endless custom solutions to help prevent the spread of COVID-19 or contact your sales representative today.



COVID19EP | © 2020 Accuform. All rights reserved.